



Is Now Part of



ON Semiconductor®

To learn more about ON Semiconductor, please visit our website at
www.onsemi.com

Please note: As part of the Fairchild Semiconductor integration, some of the Fairchild orderable part numbers will need to change in order to meet ON Semiconductor's system requirements. Since the ON Semiconductor product management systems do not have the ability to manage part nomenclature that utilizes an underscore (_), the underscore (_) in the Fairchild part numbers will be changed to a dash (-). This document may contain device numbers with an underscore (_). Please check the ON Semiconductor website to verify the updated device numbers. The most current and up-to-date ordering information can be found at www.onsemi.com. Please email any questions regarding the system integration to Fairchild_questions@onsemi.com.

ON Semiconductor and the ON Semiconductor logo are trademarks of Semiconductor Components Industries, LLC dba ON Semiconductor or its subsidiaries in the United States and/or other countries. ON Semiconductor owns the rights to a number of patents, trademarks, copyrights, trade secrets, and other intellectual property. A listing of ON Semiconductor's product/patent coverage may be accessed at www.onsemi.com/site/pdf/Patent-Marking.pdf. ON Semiconductor reserves the right to make changes without further notice to any products herein. ON Semiconductor makes no warranty, representation or guarantee regarding the suitability of its products for any particular purpose, nor does ON Semiconductor assume any liability arising out of the application or use of any product or circuit, and specifically disclaims any and all liability, including without limitation special, consequential or incidental damages. Buyer is responsible for its products and applications using ON Semiconductor products, including compliance with all laws, regulations and safety requirements or standards, regardless of any support or applications information provided by ON Semiconductor. "Typical" parameters which may be provided in ON Semiconductor data sheets and/or specifications can and do vary in different applications and actual performance may vary over time. All operating parameters, including "Typicals" must be validated for each customer application by customer's technical experts. ON Semiconductor does not convey any license under its patent rights nor the rights of others. ON Semiconductor products are not designed, intended, or authorized for use as a critical component in life support systems or any FDA Class 3 medical devices or medical devices with a same or similar classification in a foreign jurisdiction or any devices intended for implantation in the human body. Should Buyer purchase or use ON Semiconductor products for any such unintended or unauthorized application, Buyer shall indemnify and hold ON Semiconductor and its officers, employees, subsidiaries, affiliates, and distributors harmless against all claims, costs, damages, and expenses, and reasonable attorney fees arising out of, directly or indirectly, any claim of personal injury or death associated with such unintended or unauthorized use, even if such claim alleges that ON Semiconductor was negligent regarding the design or manufacture of the part. ON Semiconductor is an Equal Opportunity/Affirmative Action Employer. This literature is subject to all applicable copyright laws and is not for resale in any manner.



FAN5646

Programmable Indicator “Soft” LED Blinker with TinyWire™ Single-Wire Interface

Features

- LED “Soft” Blink: with Logarithmic Fade Up and Fade Down for Power Savings
- Follow or Repeat Pattern Mode for Blinking when Applications Processor is Powered Down
- Default Pattern Optionally Modified using TinyWire™ Single-Wire Digital Control for:
 - LED Current Rise / Fall Time
 - t_{ON} and t_{OFF} for Up to Two Pulses
- High-Side Constant Current LED Driver:
 - 20 mA Maximum Output Current
 - 80 mV Drop-out at 20 mA I_{OUT}
 - External R_{SET} (SC70 only) or Internal Current Programming
- 35 μ A Operating Quiescent Current
- Short-Circuit, Under-Voltage, and Thermal Protections
- Wide Input Range: 2.7 to 5.5 V
- 4-Bump WLCSP, 0.4 mm pitch or 5-Lead SC70 (EIAJ SC88)

Applications

- Cell Phone
- Pocket PCs and Digital Cameras
- Bluetooth® Headsets PMP and MP3 players

Description

The FAN5646 is a flexible and compact solution for a blinking or “breathing” LED indicator. The internal programmable blink algorithm eliminates any need for continual system processor control. This means longer battery life for a hand-held system because the system processor is not awakened from sleep mode to blink an LED.

Very low dropout of 80 mV allows driving an LED without any inductors or switch capacitors. LED blink rate, rise and fall time, and CTRL line behavior can be programmed by a TinyWire™ single-wire digital interface. The on-time and time between pulses can be set for up to two different pulse widths.

The default for FAN5646 option 01 is “follow” mode, where the LED turns on with the programmed rise time, then stays on as long as CTRL remains HIGH. When CTRL falls, the LED turns off at the programmed fall time. For option 00; when CTRL is HIGH continuously, the LED repeats the programmed pattern.

The FAN5646 is available in a four-pin wafer-level chip-scale package with 0.4 mm pitch or a five-lead SC70 package.

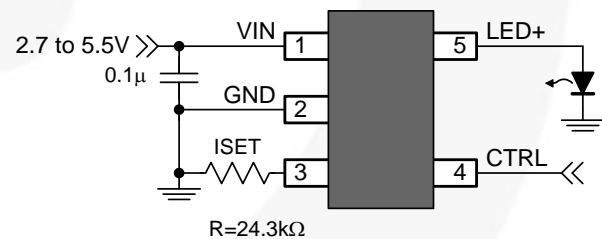

Figure 1. Typical Application

Ordering Information

Part Number	Option	Follow Bit Default	Temperature Range	Package	Packing
FAN5646UC00X	00	0	-40 to 85°C	WLCSP-4, 0.4mm Pitch	Tape and Reel
FAN5646S700X	00	0	-40 to 85°C	5-Lead SC70, EIAJ SC88	Tape and Reel
FAN5646UC01X	01	1	-40 to 85°C	WLCSP-4, 0.4mm Pitch	Tape and Reel
FAN5646S701X	01	1	-40 to 85°C	5-Lead SC70, EIAJ SC88	Tape and Reel

Bluetooth® is a registered trademark of Bluetooth SIG, Inc.

Important: Contact a Fairchild Semiconductor sales representative for additional performance information and specifications.

Pin Configuration

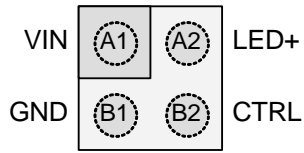

Figure 2. WLCSP – Top View: Bumps Facing Down

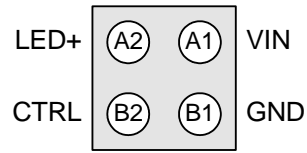

Figure 3. WLCSP – Bottom View: Bumps Facing Up

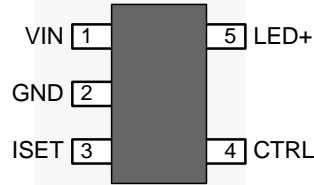

Figure 4. SC70-5 Top View

Pin Definitions

Pin #		Name	Description
WLCSP	SC70-5		
A1	1	VIN	Input Voltage. Connect to 2.7-5.5 V _{DC} input power source.
A2	5	LED+	LED Anode. LED current source output.
B1	2	GND	Ground.
B2	4	CTRL	Control pin. Logic input that controls programming and starts IC playback.
	3	ISET	LED Current Setting. Full-scale LED current is set by tying this pin through a resistor (R _{SET}) to GND. If this pin is left open, an internal current reference is used.

Absolute Maximum Ratings

Stresses exceeding the absolute maximum ratings may damage the device. The device may not function or be operable above the recommended operating conditions and stressing the parts to these levels is not recommended. In addition, extended exposure to stresses above the recommended operating conditions may affect device reliability. The absolute maximum ratings are stress ratings only.

Symbol	Parameter	Min.	Max.	Units
V _{CC}	V _{IN} , LED+, CTRL Voltage	-0.3	6.0	V
	ISET Voltage	-0.3	V _{IN} + 0.3	V
ESD	Electrostatic Discharge Protection Level	Human Body Model per JESD22-A114	8.0	kV
		Charged Device Model per JESD22-C101	2.0	
T _J	Junction Temperature	-40	+150	°C
T _{STG}	Storage Temperature	-65	+150	°C
T _L	Lead Soldering Temperature, 10 Seconds		+260	°C

Recommended Operating Conditions

The Recommended Operating Conditions table defines the conditions for actual device operation. Recommended operating conditions are specified to ensure optimal performance to the datasheet specifications. Fairchild does not recommend exceeding them or designing to absolute maximum ratings.

Symbol	Parameter	Min.	Max.	Units	
V _{IN}	Power Supply Voltage Range	2.7	5.5	V	
T _A	Operating Ambient Temperature Range	-40	+85	°C	
T _J	Operating Junction Temperature Range	-40	+125	°C	
I _{LED(FS)}	Full-Scale LED Current	If I _{SET} is OPEN		5 20	mA
R _{SET}	R _{SET} Values for ±10% I _{SET} Accuracy ⁽¹⁾	CONTROL[7:6] = 00 I _{LED} = 7.2 mA to 2.5 mA	17.4	48.7	kΩ
		CONTROL[7:6] = 01 I _{LED} = 12.1 mA to 7.1 mA	20.5	34.8	
		CONTROL[7:6] = 10 I _{LED} = 17.3 mA to 12.3 mA	21.5	30.1	
		CONTROL[7:6] = 11 I _{LED} = 20.4 mA to 17.3 mA	24.3	28.7	

Note:

1. Applicable for SC70 version only.

Electrical Specifications

$V_{IN} = 2.7\text{ V to }5.5\text{ V}$, $T_A = -40^\circ\text{C to }+85^\circ\text{C}$, $V_f = 1.8\text{ V to }[3.5\text{ V or }V_{IN} - 0.1\text{ V}]$, whichever is smaller. Typical values are at $T_A = 25^\circ\text{C}$, $V_{IN} = 3.6\text{ V}$, and $V_f = 2.5\text{ V}$.

Symbol	Parameter	Conditions	Min.	Typ.	Max.	Units	
Power Supplies							
I_{SD}	IDLE Mode Supply Current	$V_{IN} = 3.6\text{ V}$, CTRL = 0 V		0.30	0.75	μA	
I_{IN}	Quiescent Current	$V_{IN} = 3.6\text{ V}$, $I_{LED} = 0\text{ mA}$		35	80	μA	
I_{ACTIVE}	Active Mode Supply Current ⁽²⁾	$V_{IN} = 3.6\text{ V}$, LED+ = ON		220		μA	
V_{IH}	Logic Input Voltage HIGH		1.1			V	
V_{IL}	Logic Input Voltage LOW				0.4	V	
I_{IH}	Control Pin Input Current	CTRL = 1.8 V		1	250	nA	
V_{UVLO}	Under-Voltage Lockout Threshold	V_{IN} Rising		2.5		V	
		V_{IN} Falling		2.2		V	
Regulation							
I_{LED}	LED Output Current	I_{SET} OPEN	CONTROL[7:6] = 00	4.25	5.00	5.75	mA
			CONTROL[7:6] = 01	8.70	10.00	11.30	
			CONTROL[7:6] = 10	13.20	15.00	16.80	
			CONTROL[7:6] = 11	18.00	20.00	22.00	
		$R_{SET} = 24.3\text{k}\Omega$	CONTROL[7:6] = 00	4.70	5.00	5.30	
			CONTROL[7:6] = 01	9.40	10.00	10.60	
			CONTROL[7:6] = 10	14.10	15.00	15.90	
			CONTROL[7:6] = 11	18.80	20.00	21.20	
V_{ISET}	I_{SET} Drive Voltage	$12.1\text{ k}\Omega \leq R_{SET} \leq 100\text{ k}\Omega$		1.23		V	
I_{OUT_RIPPLE}	Maximum LED Ripple Current ⁽²⁾	$V_{IN} = 3.6\text{ V}$, $\Delta V_{IN} = 700\text{ mV}$, $I_{LED} = 20\text{ mA}$, $t_{rise} = t_{fall} = 10\text{ }\mu\text{s}$, $t_{LOW} = 280\text{ }\mu\text{s}$		0.5		% p-p	
ΔI_{OUT_LOAD}	I_{OUT} Load Regulation	LED $V_f = 1.8\text{ to }3.45\text{ V}$, $V_{IN} = 3.6\text{ V}$	-3		+3	%	
ΔI_{OUT_LINE}	I_{OUT} Line Regulation	$V_{IN} = 2.7\text{ to }4.8\text{ V}$, $V_f = 2.5\text{ V}$	-3		+3	%	
$V_{DROPOUT}$	Dropout Voltage	$I_{LED} = 20\text{ mA}$, -10% I_{LED} Drop		80		mV	
TSD	Thermal Shutdown	Rising Temperature at Junction		150		$^\circ\text{C}$	
		Hysteresis		20			
Timing							
f_{OSC}	Internal Oscillator Frequency	$V_{IN} = 3.6\text{ V}$	61	77	93	kHz	
T_{OSC}	Oscillator Stability Over Temperature ⁽²⁾			± 3		%	

Note:

- These parameters are guaranteed by design and characterization.

Typical Characteristics

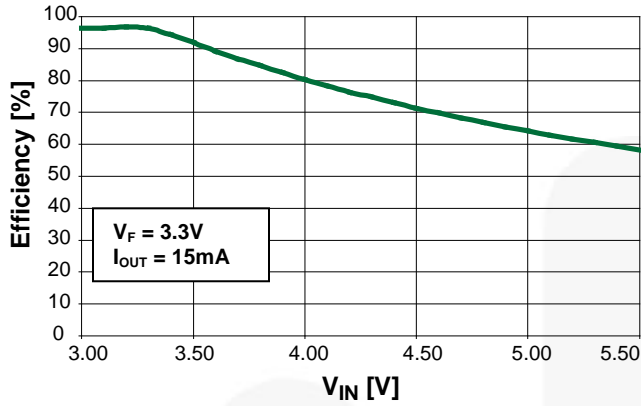

Figure 5. Efficiency at 25°C

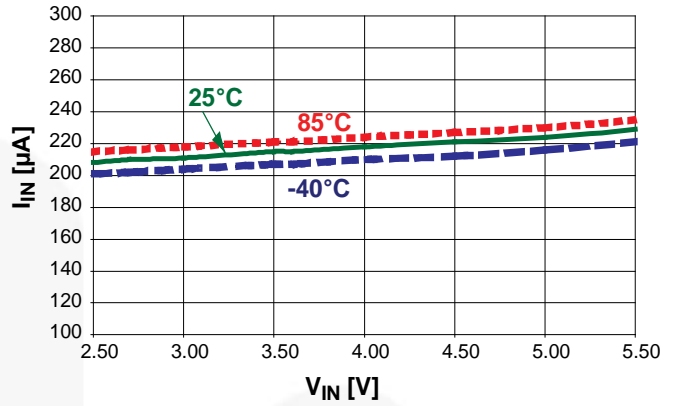

Figure 6. Active Mode Supply Current (LED+ = ON)

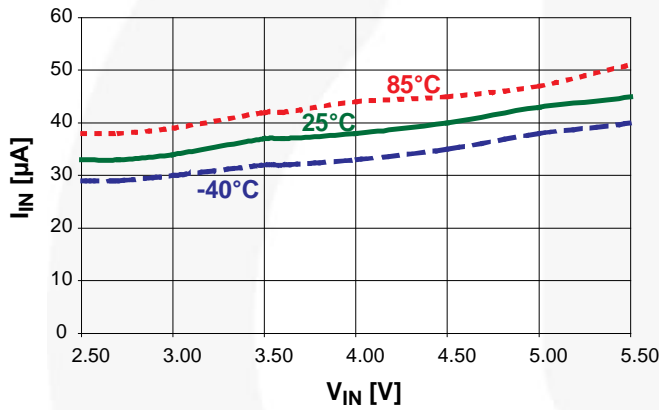

Figure 7. Quiescent Current (ILED = 0 mA)

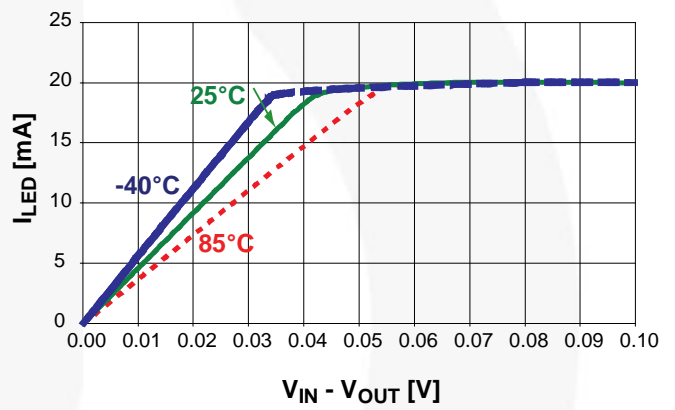

Figure 8. Output Current vs. Headroom Voltage

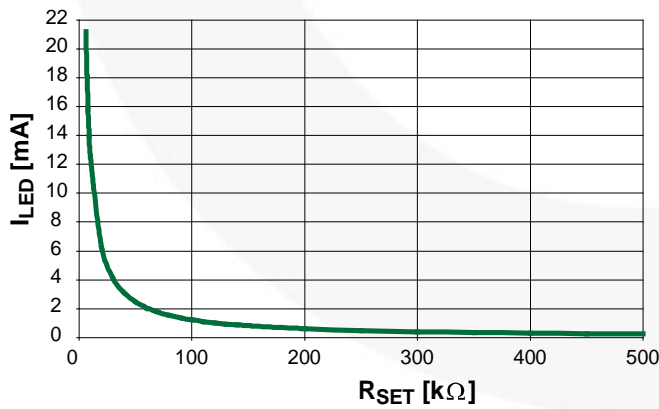

Figure 9. Output Current vs. RSET at 25°C

Circuit Description

Operating Modes

At power up, the device is in IDLE (“sleep”) Mode until a rising edge of a CTRL signal is detected. When both the PLAY and FOLLOW bits are 0, the FAN5646 executes the LED pattern shown in Figure 10. If the length of the CTRL pulse is less than 1.7 s, only the initial pulse is seen. A CTRL pulse that is kept HIGH after the initial 1.7 s pulse causes the FAN5646 to go into PLAY mode where PULSE1 and PULSE2 are played as programmed in the registers (see Table 9).

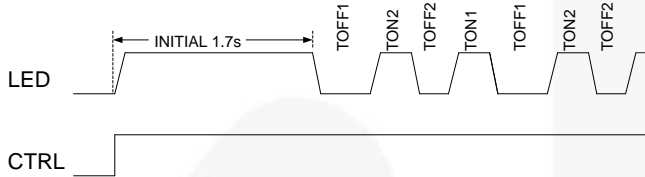

Figure 10. Initial Pulse Mode Timing

Table 1. CTRL Pin Operation, CONTROL[1:0] = 00

Mode	LED	Entry
IDLE	OFF	CTRL LOW for > 200 μ s
PLAY	Play Pattern	CTRL HIGH > 2 s
FOLLOW	Follows CTRL	CTRL HIGH < 2 s
Program	OFF	CTRL HIGH < 50 μ s

The behavior described in Table 1 can be changed using the PLAY and FOLLOW bits (see Table 3).

In PLAY Mode, the default pattern of PULSE1 repeats when CTRL is held HIGH while PULSE2 is always ignored (see Table 2). The FAN5646 plays the programmed sequence for blinking the LED until CTRL is set LOW. The programmed LED pattern always starts with PULSE1 and it can have t_{ON} and t_{OFF} times that are multiples of 106ms (see Equation (4)) while PULSE2 is disabled when its respective t_{ON} and t_{OFF} times are set to zero.

Table 2. PULSE1 Default Pattern – PLAY Mode

t_{RISE}	t_{FALL}	t_{ON}	t_{OFF}
516ms	516ms	533ms	1600ms

The IC creates the rise and fall profiles in Figure 11 by stepping through PWM dimming values given in Table 4 and Table 5. The SLEW1 and SLEW2 registers control the brightness of the LED for PULSE1 and PULSE2, respectively. In the example in Table 2, only the SLEW1 register is programmed with the brightness level for the LED.

In FOLLOW Mode, the LED+ pin is ON when CTRL is HIGH and, as such, follows the CTRL signal applied to FAN5646.

Play and Follow Bits

Table 3. PLAY and FOLLOW Bit Definition

PLAY	FOLLOW	Behavior
0	0	Default Behavior per Table 1*
0	1	LED Follows CTRL**
1	0	LED Enters PLAY Mode
1	1	LED Enters One-Shot Mode

One-Shot Mode

This mode is enabled when the PLAY and FOLLOW bits are both 1. One-Shot Mode is similar to PLAY mode except that PULSE1 is enabled while PULSE2 is always ignored. In One-Shot Mode, PULSE1 is played after CTRL is held HIGH for at least 200 μ s. Once PULSE1 is initiated, CTRL is ignored until PULSE1 is completed. If CTRL remains HIGH through the t_{OFF} time of PULSE1, PULSE1 continues to replay until CTRL is lowered. Therefore, One-Shot Mode enables the LED to blink in the programmed pattern as long as CTRL is HIGH.

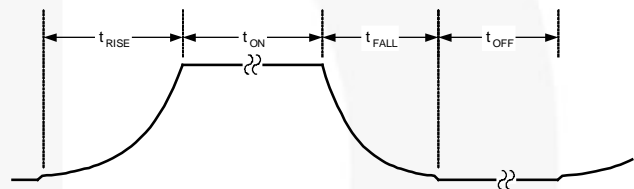

Figure 11. LED Average Current Profile

Table 4. Brightness Steps during Fade Up/Down (12.5%)

$I_{OUT(DC)} = 12.5\%$ of Full Scale			
Step #	t_{ON} (μ s)	t_{OFF} (μ s)	% of Full Power
0	0	3,333	0.00%
1	13	3,320	0.05%
2	65	3,268	0.24%
3	156	3,177	0.60%
4	299	3,034	1.10%
5	482	2,852	1.80%
6	716	2,617	2.70%
7	1,016	2,318	3.80%

* Default setting for FAN5646_00

** Default setting for FAN5646_01

Table 5. Brightness Steps During Fade Up/Down (100%)

I_{OUT(DC)} = 100% of Full Scale			
Step #	t_{ON} (μs)	t_{OFF} (μs)	% of Full Power
8	169	3,164	5.1%
9	221	3,112	6.6%
10	273	3,060	8.2%
11	339	2,995	10.2%
12	417	2,917	12.5%
13	495	2,839	14.8%
14	586	2,747	17.6%
15	677	2,656	20.3%
16	781	2,552	23.4%
17	885	2,448	26.6%
18	1,003	2,331	30.1%
19	1,133	2,201	34.0%
20	1,276	2,057	38.3%
21	1,419	1,914	42.6%
22	1,563	1,771	46.9%
23	1,732	1,602	52.0%
24	1,901	1,432	57.0%
25	2,070	1,263	62.1%
26	2,266	1,068	68.0%
27	2,461	872	73.8%
28	2,669	664	80.1%
29	2,878	456	86.3%
30	3,099	234	93.0%
31	3,333	0	100.0%

Changing the Default Values

The default values for the customer-accessible registers produce the fixed t_{ON}, t_{OFF}, t_{RISE}, and t_{FALL} illustrated in Table 2. These values can be changed using registers (see Table 9) accessible through the TinyWire™ single-wire interface.

The PLAY and FOLLOW control bits define the FAN5646 IC behavior (Table 1) of the CTRL line. In addition, the full-scale LED current can be changed (Table 6).

LED Full-Scale Current

The full-scale LED current can be set using the I_{SET} bits (CONTROL[7:6]) to accommodate a wide variety of LEDs.

When CTRL first goes HIGH, the IC determines if an R_{SET} is connected. If the I_{SET} is open or shorted to ground, I_{LED} is set by an internal reference according to Table 6:

Table 6. LED Maximum Current, WLCSP or I_{SET} Open

I_{SET} Bits	I_{LED(MAX)} (mA)
00 ^{***}	5
01	10
10	15
11	20

I_{LED} can be programmed with an external R_{SET} resistor to GND in conjunction with the I_{SET} bits:

$$I_{LED} = \frac{K}{R_{SET} - 200} \quad \text{or} \quad (1)$$

$$R_{SET} = \frac{K}{I_{LED}} + 200$$

Table 7. LED Programming R_{SET}

I_{SET} Bits	K
00 ^{***}	123
01	246
10	369
11	492

R_{SET} should be between 12.1 kΩ and 100 kΩ, which corresponds to a range of 20 mA and 2.5 mA respectively when the I_{SET} bits are 01 and I_{LED(max)} = 10 mA. To achieve the highest accuracy using an external R_{SET}, program the I_{SET} bits for the I_{LED} closest to the desired I_{LED} based on the I_{SET} values in Table 6. Then calculate the appropriate R_{SET} for the desired I_{SET} using Equation (1) with the K value for the chosen I_{SET} bit value from Table 7.

RISE and FALL

The IC creates the rise and fall profiles in Figure 11 by incrementing or decrementing the PWM dimming value at a rate determined by the SLEW1 and SLEW2 registers. t_{RISE} or t_{FALL} are determined by the following equation:

$$t_{RISE} = 31 \times N_{RISE} \times 3.33\text{ms} \quad (2)$$

$$t_{FALL} = 31 \times N_{FALL} \times 3.33\text{ms} \quad (3)$$

where N_{RISE} and N_{FALL} are decimal values in the SLEW registers (Table 9). Therefore, the maximum time for rise or fall time to or from full current is:

$$t_{RISE/FALL} (\text{max}) = 1550\text{ms}$$

If the value of N_{RISE} or N_{FALL} is 0, the LED goes to (or from) off to full brightness with no brightness ramp. Therefore, the minimum time for controlled brightness stepping to full current (N_{RISE} = 1) is:

$$t_{RISE/FALL} (\text{min}) = 103 \text{ ms}$$

PULSE1 and PULSE2 have independently programmable t_{RISE} and t_{FALL}.

^{***} Default setting for the I_{SET} bits.

t_{ON} and t_{OFF}

The FAN5646 is capable of two pulses of different lengths with independently programmable t_{ON}, t_{RISE}, and t_{FALL}. The time between each of these pulses is established by t_{OFF}.

$$t_{ON} = (SLOW + 1) \times N_ON \times 106.6ms \quad (4)$$

$$t_{OFF} = (SLOW + 1) \times N_OFF \times 320ms \quad (5)$$

where SLOW is the value of the SLOW bit (CONTROL[2] – register), which is 1 or 0. N_ON and N_OFF values are PULSE1 and PULSE2 register values (Table 9).

Table 8. t_{ON} and t_{OFF} Maximum Values

	SLOW Bit	Maximum	Units
t _{ON}	0	1600	ms
t _{OFF}	0	4800	ms
t _{ON}	1	3200	ms
t _{OFF}	1	9600	ms

If t_{ON} is 0, the LED current ramps down immediately after attaining its FINAL value. The minimum t_{ON} and t_{OFF} for PULSE1 is 6.7 ms, while PULSE2 is disabled when either t_{ON} or t_{OFF} is 0.

If N_ON_{PULSE2} and N_OFF_{PULSE2} are both 0, only the t_{ON_PULSE1} and t_{OFF_PULSE1} are considered.

Table 9. Register Definition

Register	Address (Hex)	Default (Hex)	7	6	5	4	3	2	1	0
SLEW1	0	55	NRISE1: Duration of each brightness level during LED turn-on				NFALL1: Duration of each brightness level during LED turn-off			
PULSE1	1	55	N_ON1: Duration the LED stays on at 100% brightness				N_OFF1: Duration the LED stays off after ramping down			
SLEW2	2	55	NRISE2: Duration of each brightness level during LED turn-on				NFALL2: Duration of each brightness level during LED turn-off			
PULSE2	3	00	N_ON2: Duration the LED stays on at 100% brightness				N_OFF2: Duration the LED stays off after ramping down			
CONTROL	4	00 ⁽³⁾ 01 ⁽⁴⁾	I _{SET}		RESERVED			SLOW	PLAY	FOLLOW

Notes:

- 3. Default value for FAN5646_00.
- 4. Default value for FAN5646_01.

Programming Examples

The example in Table 10 and Figure 12 illustrates the relationship between the default register contents and the pattern of the IC in PLAY mode. **BOLD** signifies the decimal values of the controlling registers.

Table 10. PULSE1 Default Example (see Table 2 and Table 9)

$t_{FALL1} = t_{RISE1} = 31 \times \mathbf{5} \times 3.33 \text{ ms} = 516 \text{ ms}$
$t_{ON1} = \mathbf{5} \times 106.6 \text{ ms} = 533 \text{ ms}$
$t_{OFF1} = \mathbf{5} \times 320 \text{ ms} = 1600 \text{ ms}$

Register	SLEW1	PULSE1	SLEW2	PULSE2	CONTROL
Value (HEX)	55	55	00	00	02

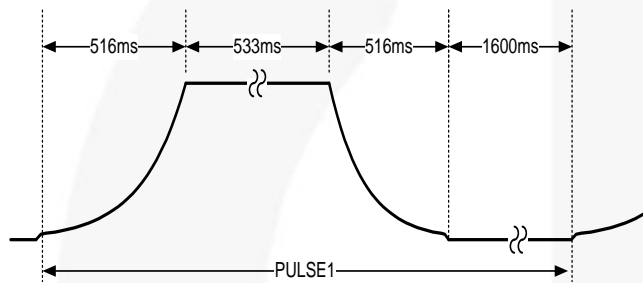

Figure 12. PULSE1 Default LED Current Pattern for Register in Table 10

The example in Table 11 and Figure 13 illustrates a long-duration pulse followed by a short-duration pulse with two seconds between each pulse; with rise and fall times of each using default values.

Table 11. Long-Short Pattern Example (see Figure 13)

$t_{FALL1} = t_{RISE1} = 31 \times \mathbf{5} \times 3.33 \text{ ms} = 516 \text{ ms}$
$t_{ON1} = \mathbf{10} \times 106.6 \text{ ms} = 1066 \text{ ms}$
$t_{OFF1} = \mathbf{9} \times 320 \text{ ms} = 2880 \text{ ms}$
$t_{FALL2} = t_{RISE2} = 31 \times \mathbf{1} \times 3.33 \text{ ms} = 103 \text{ ms}$
$t_{ON2} = \mathbf{2} \times 106.6 \text{ ms} = 213 \text{ ms}$
$t_{OFF2} = \mathbf{5} \times 320 \text{ ms} = 1600 \text{ ms}$

Register	SLEW1	PULSE1	SLEW2	PULSE2	CONTROL
Value (HEX)	55	A9	11	25	02

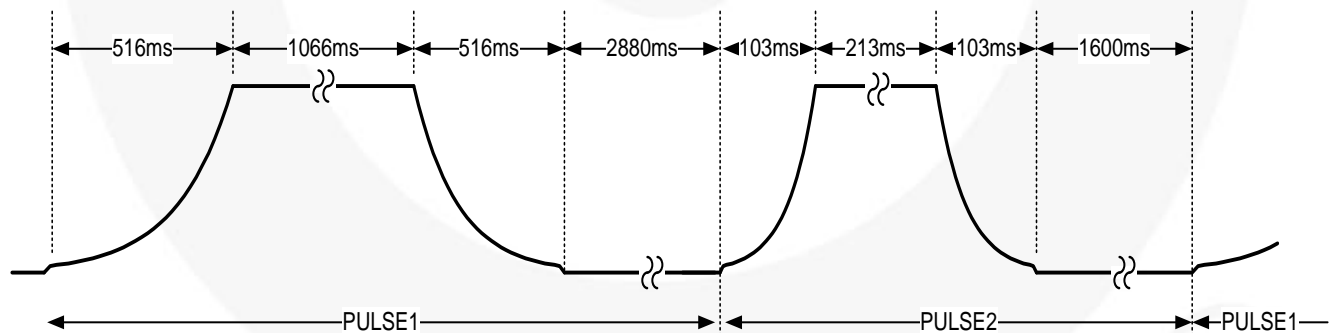

Figure 13. LED Current Waveform for Register Settings in Table 11

TinyWire™ Digital Interface

TinyWire is a flexible, general-purpose, binary protocol designed to minimize the number of pins on the IC while providing a complete digital interface that can be driven from any microcontroller or applications processor using “bit banging” on a general-purpose I/O pin. The interface’s speed and flexibility accommodate a wide range of processor clock capabilities. The fully static nature of the interface requires that the applications processor dedicate only sufficient uninterrupted attention to bit banging to complete a single packet. Interrupted packets are ignored and may be subsequently retransmitted.

The CONTROL word contains the address of the register that receives the data, followed by the data to be written. The CONTROL word is shifted LSB first on the CTRL line, as shown in Figure 14. The TinyWire protocol operates over a wide range of t_{BIT} times (see Table 13), allowing encoding of the brightness control bit-stream using a microcontroller software “bit-bang” loop.

The CONTROL word begins with the rising edge of CTRL. If CTRL is HIGH for a greater percentage of the time than it is LOW between rising edges, the bit is a 1. Conversely, if CTRL is LOW longer than it is HIGH, the bit is a 0. Observe the following timing rules to ensure proper data transmission:

Table 12. Data Bit Definition

BIT =	t_{LOW}	t_{HIGH}
0	$\geq 75\% t_{BIT}$	$\leq 25\% t_{BIT}$
1	$\leq 25\% t_{BIT}$	$\geq 75\% t_{BIT}$

Table 13. Timing Requirements

	Minimum	Maximum
t_{LOW}	500 ns	40 μ s
t_{HIGH}	500 ns	40 μ s
t_{RESET}	200 μ s	

Data is written to the selected register at the rising edge of the STOP bit. A new CONTROL word may start within 4 μ s of the falling edge of the STOP bit.

As indicated in Table 1, if CTRL remains LOW for at least t_{RESET} after the falling edge of the STOP bit, the IC reverts to its IDLE state.

If CTRL remains HIGH for at least t_{RESET} , the IC executes its programmed commands.

CONTROL Word

The CONTROL word contains the address of the register to receive the data followed by the data to be written. The FAN5646 data transfer is an 11-bit word, with the first three bits (0 through 2) being the register address, LSB first. The next eight bits (3 through 10) are the data to be written to the selected register, LSB first. Data is latched into the selected register at the rising edge of the STOP bit. A new word may be transferred to the IC as little as 4 μ s after the falling edge of the STOP bit.

Table 14 shows the CONTROL word structure as well as an example of writing 23H into register 2 ($A[2:0] = 010$).

Table 14. Address and Data Word

BIT	0	1	2	3	4	5	6	7	8	9	10
Value	A0	A1	A2	D0	D1	D2	D3	D4	D5	D6	D7
Example	0	1	0	1	1	0	0	0	1	0	0

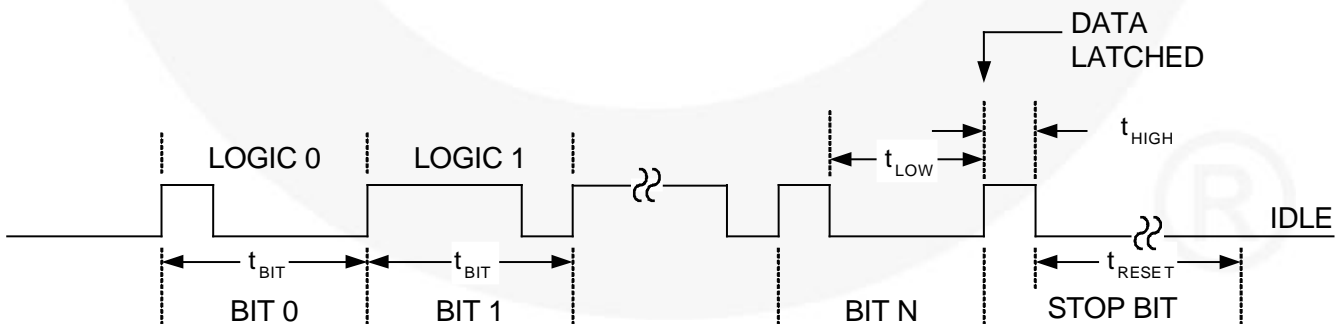
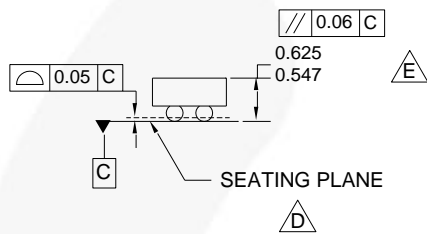
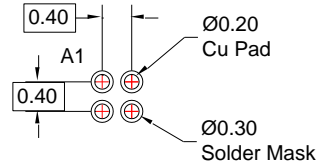
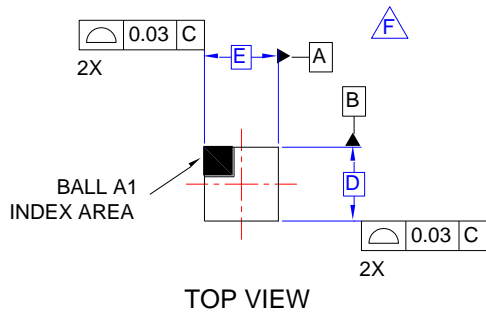
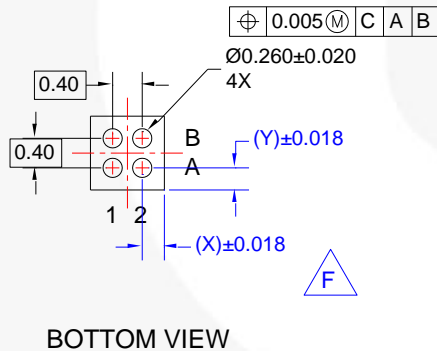

Figure 14. TinyWire™ Protocol

Physical Dimensions



SIDE VIEWS



BOTTOM VIEW

NOTES:

- A. NO JEDEC REGISTRATION APPLIES.
- B. DIMENSIONS ARE IN MILLIMETERS.
- C. DIMENSIONS AND TOLERANCE PER ASME Y14.5M, 1994.
- D. DATUM C IS DEFINED BY THE SPHERICAL CROWNS OF THE BALLS.
- E. PACKAGE NOMINAL HEIGHT IS 586 MICRONS ±39 MICRONS (547-625 MICRONS).
- F. FOR DIMENSIONS D, E, X, AND Y SEE PRODUCT DATASHEET.
- G. DRAWING FILNAME: MKT-UC004ACrev2.

Figure 15. 4-Bump WLCSP, 0.4 mm Pitch

Product-Specific Dimensions

Product	D	E	X	Y
FAN5646UC	0.820 mm	0.820 mm	0.210 mm	0.210 mm

Package drawings are provided as a service to customers considering Fairchild components. Drawings may change in any manner without notice. Please note the revision and/or date on the drawing and contact a Fairchild Semiconductor representative to verify or obtain the most recent revision. Package specifications do not expand the terms of Fairchild's worldwide terms and conditions, specifically the warranty therein, which covers Fairchild products.

Always visit Fairchild Semiconductor's online packaging area for the most recent package drawings:
<http://www.fairchildsemi.com/packaging/>

Physical Dimensions (Continued)

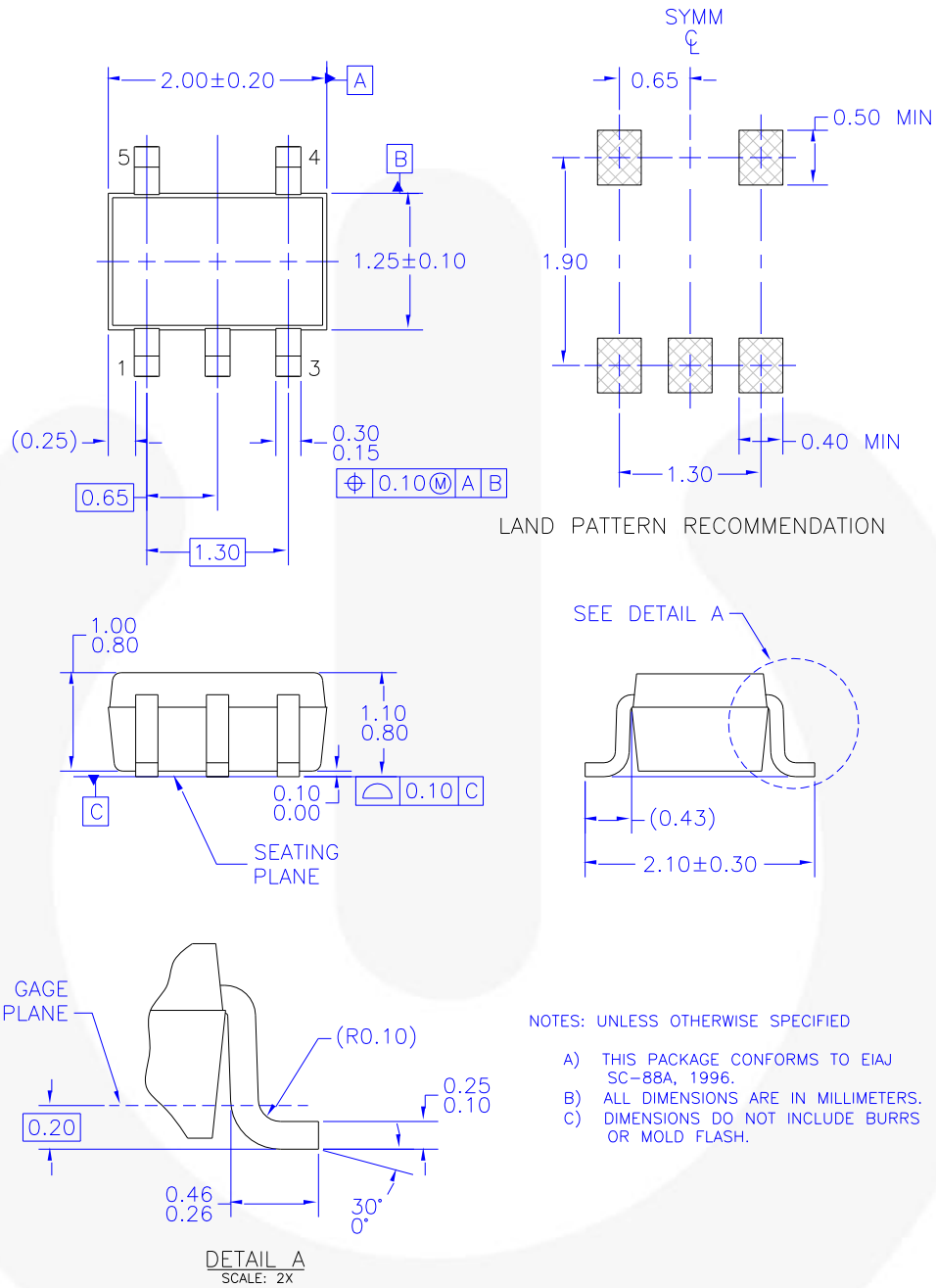

MAA054REV5

Figure 16. 5-Lead SC70 (EIAJ SC88)





Package drawings are provided as a service to customers considering Fairchild components. Drawings may change in any manner without notice. Please note the revision and/or date on the drawing and contact a Fairchild Semiconductor representative to verify or obtain the most recent revision. Package specifications do not expand the terms of Fairchild's worldwide terms and conditions, specifically the warranty therein, which covers Fairchild products.

Always visit Fairchild Semiconductor's online packaging area for the most recent package drawings:
<http://www.fairchildsemi.com/packaging/>



TRADEMARKS

The following includes registered and unregistered trademarks and service marks, owned by Fairchild Semiconductor and/or its global subsidiaries, and is not intended to be an exhaustive list of all such trademarks.

- | | | | |
|---|--|---|---|
| 2Cool™ | FPS™ |  | Sync-Lock™ |
| AccuPower™ | F-PFS™ | PowerTrench® |  |
| AX-CAP®* | FRFET® | PowerXS™ | TinyBoost™ |
| BitSiC™ | Global Power Resource™ | Programmable Active Droop™ | TinyBuck™ |
| Build it Now™ | GreenBridge™ | QFET® | TinyCalc™ |
| CorePLUS™ | Green FPS™ | QS™ | TinyLogic® |
| CorePOWER™ | Green FPS™ e-Series™ | Quiet Series™ | TINYOPTO™ |
| CROSSVOLT™ | Gmax™ | RapidConfigure™ | TinyPower™ |
| CTL™ | GTO™ |  | TinyPWM™ |
| Current Transfer Logic™ | IntelliMAX™ | Saving our world, 1mW/W/kW at a time™ | TinyWire™ |
| DEUXPEED® | ISOPLANAR™ | SignalWise™ | TransiC™ |
| Dual Cool™ | Making Small Speakers Sound Louder and Better™ | SmartMax™ | TriFault Detect™ |
| EcoSPARK® | MegaBuck™ | SMART START™ | TRUECURRENT®* |
| EfficientMax™ | MICROCOUPLER™ | Solutions for Your Success™ | µSerDes™ |
| ESBC™ | MicroFET™ | SPM® |  |
|  | MicroPak™ | STEALTH™ | UHC® |
| Fairchild® | MicroPak2™ | SuperFET® | Ultra FRFET™ |
| Fairchild Semiconductor® | MillerDrive™ | SuperSOT™-3 | UniFET™ |
| FACT Quiet Series™ | MotionMax™ | SuperSOT™-6 | VCM™ |
| FACT® | mWSaver™ | SuperSOT™-8 | VisualMax™ |
| FAST® | OptoHi™ | SupreMOS® | VoltagePlus™ |
| FastvCore™ | OPTOLOGIC® | SyncFET™ | XS™ |
| FETBench™ | OPTOPLANAR® | | |

* Trademarks of System General Corporation, used under license by Fairchild Semiconductor.

DISCLAIMER

FAIRCHILD SEMICONDUCTOR RESERVES THE RIGHT TO MAKE CHANGES WITHOUT FURTHER NOTICE TO ANY PRODUCTS HEREIN TO IMPROVE RELIABILITY, FUNCTION, OR DESIGN. FAIRCHILD DOES NOT ASSUME ANY LIABILITY ARISING OUT OF THE APPLICATION OR USE OF ANY PRODUCT OR CIRCUIT DESCRIBED HEREIN; NEITHER DOES IT CONVEY ANY LICENSE UNDER ITS PATENT RIGHTS, NOR THE RIGHTS OF OTHERS. THESE SPECIFICATIONS DO NOT EXPAND THE TERMS OF FAIRCHILD'S WORLDWIDE TERMS AND CONDITIONS, SPECIFICALLY THE WARRANTY THEREIN, WHICH COVERS THESE PRODUCTS.

LIFE SUPPORT POLICY

FAIRCHILD'S PRODUCTS ARE NOT AUTHORIZED FOR USE AS CRITICAL COMPONENTS IN LIFE SUPPORT DEVICES OR SYSTEMS WITHOUT THE EXPRESS WRITTEN APPROVAL OF FAIRCHILD SEMICONDUCTOR CORPORATION.

As used herein:

1. Life support devices or systems are devices or systems which, (a) are intended for surgical implant into the body or (b) support or sustain life, and (c) whose failure to perform when properly used in accordance with instructions for use provided in the labeling, can be reasonably expected to result in a significant injury of the user.
2. A critical component in any component of a life support, device, or system whose failure to perform can be reasonably expected to cause the failure of the life support device or system, or to affect its safety or effectiveness.

ANTI-COUNTERFEITING POLICY

Fairchild Semiconductor Corporation's Anti-Counterfeiting Policy. Fairchild's Anti-Counterfeiting Policy is also stated on our external website, www.fairchildsemi.com, under Sales Support.

Counterfeiting of semiconductor parts is a growing problem in the industry. All manufacturers of semiconductor products are experiencing counterfeit parts. Customers who inadvertently purchase counterfeit parts experience many problems such as loss of brand reputation, substandard performance, failed applications, and increased cost of production and manufacturing delays. Fairchild is taking strong measures to protect ourselves and our customers from the proliferation of counterfeit parts. Fairchild strongly encourages customers to purchase Fairchild parts either directly from Fairchild or from Authorized Fairchild Distributors who are listed by country on our web page cited above. Products customers buy either from Fairchild directly or from Authorized Fairchild Distributors are genuine parts, have full traceability, meet Fairchild's quality standards for handling and storage and provide access to Fairchild's full range of up-to-date technical and product information. Fairchild and our Authorized Distributors will stand behind all warranties and will appropriately address any warranty issues that may arise. Fairchild will not provide any warranty coverage or other assistance for parts bought from Unauthorized Sources. Fairchild is committed to combat this global problem and encourage our customers to do their part in stopping this practice by buying direct or from authorized distributors.

PRODUCT STATUS DEFINITIONS

Definition of Terms

Datasheet Identification	Product Status	Definition
Advance Information	Formative / In Design	Datasheet contains the design specifications for product development. Specifications may change in any manner without notice.
Preliminary	First Production	Datasheet contains preliminary data; supplementary data will be published at a later date. Fairchild Semiconductor reserves the right to make changes at any time without notice to improve design.
No Identification Needed	Full Production	Datasheet contains final specifications. Fairchild Semiconductor reserves the right to make changes at any time without notice to improve the design.
Obsolete	Not In Production	Datasheet contains specifications on a product that is discontinued by Fairchild Semiconductor. The datasheet is for reference information only.

Rev. 164

ON Semiconductor and  are trademarks of Semiconductor Components Industries, LLC dba ON Semiconductor or its subsidiaries in the United States and/or other countries. ON Semiconductor owns the rights to a number of patents, trademarks, copyrights, trade secrets, and other intellectual property. A listing of ON Semiconductor's product/patent coverage may be accessed at www.onsemi.com/site/pdf/Patent-Marking.pdf. ON Semiconductor reserves the right to make changes without further notice to any products herein. ON Semiconductor makes no warranty, representation or guarantee regarding the suitability of its products for any particular purpose, nor does ON Semiconductor assume any liability arising out of the application or use of any product or circuit, and specifically disclaims any and all liability, including without limitation special, consequential or incidental damages. Buyer is responsible for its products and applications using ON Semiconductor products, including compliance with all laws, regulations and safety requirements or standards, regardless of any support or applications information provided by ON Semiconductor. "Typical" parameters which may be provided in ON Semiconductor data sheets and/or specifications can and do vary in different applications and actual performance may vary over time. All operating parameters, including "Typicals" must be validated for each customer application by customer's technical experts. ON Semiconductor does not convey any license under its patent rights nor the rights of others. ON Semiconductor products are not designed, intended, or authorized for use as a critical component in life support systems or any FDA Class 3 medical devices or medical devices with a same or similar classification in a foreign jurisdiction or any devices intended for implantation in the human body. Should Buyer purchase or use ON Semiconductor products for any such unintended or unauthorized application, Buyer shall indemnify and hold ON Semiconductor and its officers, employees, subsidiaries, affiliates, and distributors harmless against all claims, costs, damages, and expenses, and reasonable attorney fees arising out of, directly or indirectly, any claim of personal injury or death associated with such unintended or unauthorized use, even if such claim alleges that ON Semiconductor was negligent regarding the design or manufacture of the part. ON Semiconductor is an Equal Opportunity/Affirmative Action Employer. This literature is subject to all applicable copyright laws and is not for resale in any manner.

PUBLICATION ORDERING INFORMATION

LITERATURE FULFILLMENT:

Literature Distribution Center for ON Semiconductor
19521 E. 32nd Pkwy, Aurora, Colorado 80011 USA
Phone: 303-675-2175 or 800-344-3860 Toll Free USA/Canada
Fax: 303-675-2176 or 800-344-3867 Toll Free USA/Canada
Email: orderlit@onsemi.com

N. American Technical Support: 800-282-9855 Toll Free
USA/Canada
Europe, Middle East and Africa Technical Support:
Phone: 421 33 790 2910
Japan Customer Focus Center
Phone: 81-3-5817-1050

ON Semiconductor Website: www.onsemi.com
Order Literature: <http://www.onsemi.com/orderlit>
For additional information, please contact your local
Sales Representative

Mouser Electronics

Authorized Distributor

Click to View Pricing, Inventory, Delivery & Lifecycle Information:

[ON Semiconductor:](#)

[FAN5646S701X](#) [FAN5646UC01X](#) [FAN5646UC00X](#) [FAN5646S700X](#)